



Specifications

Technical details

| | |
|-------------------------|-------------------------------|
| Frame | Steel, powder coated |
| Motor | 24V DC, 300W, 100 rpm |
| Weight | 154 kg |
| Weight trailer | Max. 2500 kg |
| Battery | Exchangeable battery pack |
| Speed Max. | 3,8 km/h, freely programmable |
| Drive wheels | Vulcalon Ø 200 x 50 mm |
| Adze height | 770-1152 mm (variable) |
| Noise level | 63,8 dB |
| To use from | -10 °C / 40 °C |
| Protection class | Machine IP44 |
| Lifting capacity | 1500 kg |

© 2019 Movexx International B.V. The images shown are used for illustration purposes only and may differ from the products indicated. No rights can therefore be derived from it. Printing errors are subjected to change.

Pulling power (in kg)

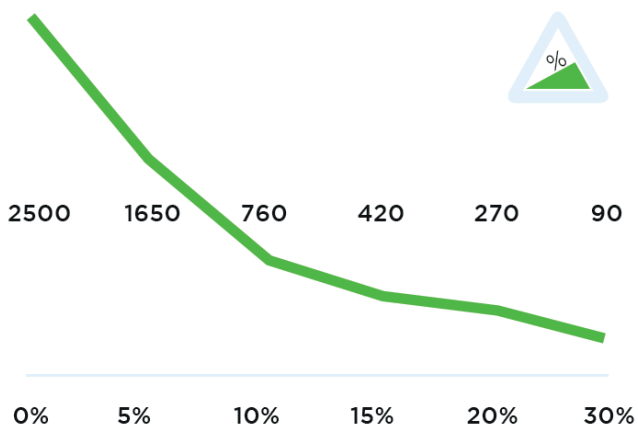

Measured with a trolley with 2 swivel wheels and 2 fixed castors. Wheel Ø 160 mm.

Dimensions

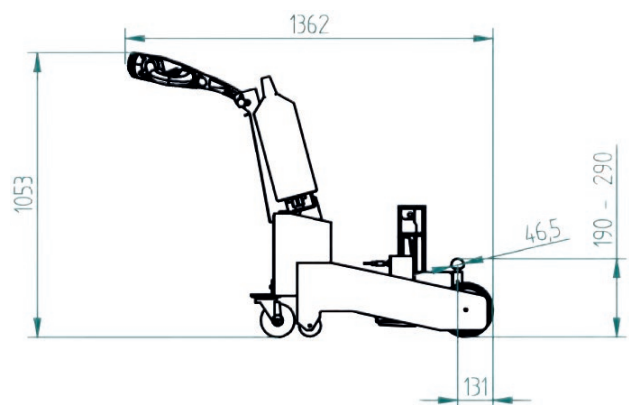
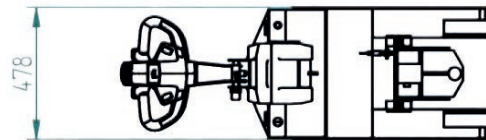

Standard parts



Motor 600W / 100rpm
(6911413X) with brake
Item number M2098



LED battery indicator
Item number M0123



Charger (external)
Lithium battery 25,6V / 10A
Item number OPT0013



Lithium battery green
(LiFePO4) 25,5V / 36Ah
Item number OPT0106



Drive wheel
Ø 200 x 50 mm
Item number M0340



Caster wheel
Black Ø 125 mm
Item number M0110

Standard parts



Adjustable tiller head
Item no M1002-0100



Belly button RED
Item number M0121-BBUT



2 programmable speeds

Options



Horn 90dB
Item number OPT0045



Horn 90dB for
steel tiller head supp.
M1002-0100
Item number OPT0057

Options



Horn 103dB
Item number OPT0059



Emergency stop
Item number OPT0063



Strobe light
cast iron tillerhead
Item number OPT0076



Strobe light for
steel tiller head supp.
M1002-0100
Item number OPT0065

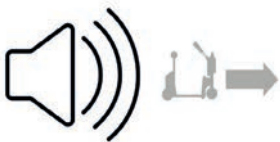

Audio signal
(while driving)
Item number OPT0253

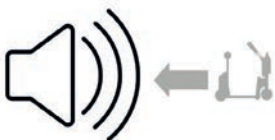

Audio signal
(driving backward)
Item number OPT0254

Options



Hour tracker
Item number OPT0056



Antistatic strip
Item number OPT0058



Code lock
Item number OPT0068

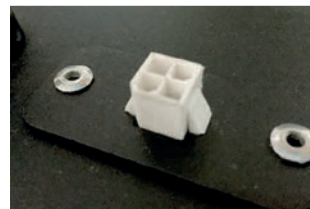

Diagnostic connector
Item number OPT0270



Ignition key (unequal)
Item number OPT0145



Ignition key (equal)
Item number OPT0146

Options



On/off rotary switch
Item number OPT0016



Parking floorlabel Ø 60 cm
Item number OPT0245



Customized programming
Please indicate specific settings
Item number OPT0170



Programmer for Italsea
Item number D0003



Screw tube
Item number OPT0301



Urgent order purchase
Item number SPOED

Batteries and Chargers



Charger (external)
Lithium battery 25,6V / 10A
Item number OPT0013



Lithium battery green
(LiFePO4) 25,6V / 36Ah
Item number OPT0106



Wall mounted Lithium
charger
Item number OPT0023



Wall mounted Lithium
charger (5x), incl. Lithium
charger 25,6V / 10A
Item number OPT0029



UPGRADE:
Wall mounting for charger
(for AGM or Lithium)
Item number OPT0261

Most common spareparts



Charger (external)
Lithium battery 25,6V / 10A
Item number OPT0013



Lithium battery green
(LiFePO4) 25,6V / 36Ah
Item number OPT0106



Battery guide
(stainless steel)
Item number M0482



Belly button RED
Item number M0121-BBUT



Switch buttons (2x) green
Item number M0121-KNOP-GROEN



Switch tiller head
excl. buttons
Item number M0121-FLIPPER

Most common spareparts



Feather/shaft Throttle
Item number M0121-4



Switch FAST/SLOW
tiller head green
Item number M0121-SPEED-GROEN



Switch UP/DOWN
tiller head green
Item number M0121-UPDOWN-GROEN



Plain sleeve bearing
Ø8 / 12 x 6, 16 x 2 mm
Item number M4038



Locking pin
M16 x 1,5 mm
Item number M0001



Coverplate tiller head
Item number M0898

Most common spareparts



Italsea drive controller
in 24V / 36 bat,
in 30A / I_{max} 120A
Item number M2128



Carbon brushes (set of 4)
for Motor 600W
Item number M1037



LED battery indicator
Item number M0123

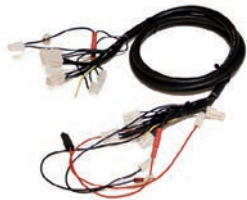

Cable harness complete
Item number M1127-M050



Fuse 5A
Item number M0506



Fuse Maxi 40A
Item number M0254

Most common spareparts



Drive wheel
Ø 200 x 50 mm
Item number M0340



Caster wheel
Black Ø 80 mm
Item number M0319



Caster wheel
Black Ø 125 mm
Item number M0110

applications



moveXX
driven by brain power

Generatorstraat 17-19
3903 LH Veenendaal
The Netherlands

T +31 (0)318 519900
E info@movexx.com
W www.movexx.com

