



Movexx **T1000-P**
PARTS & OPTIONS

Aug. **2019**

Specifications

Technical details

Frame	Steel, powder coated
Motor	24V DC, 300W, 100 rpm
Weight	154 kg (incl. accu)
Weight trailer	Max. 1000 kg
Battery	Exchangeable battery pack
Speed Max.	3,8 km/h, freely programmable
Drive wheels	Vulcalon Ø 200x50 mm
Adze height	770-1152mm (variable)
Noise level	63,8 dB
To use from	-10 °C / 40 °C
Protection class	Machine IP44
Lifting capacity	600 kg

© 2019 Movexx International B.V. The images shown are used for illustration purposes only and may differ from the products indicated. No rights can therefore be derived from it. Printing errors are subjected to change.

Pulling power (in kg)

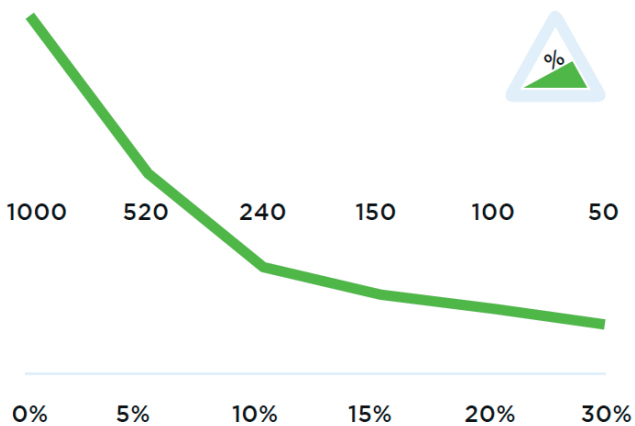

Measured with a trolley with 2 swivel wheels and 2 fixed castors. Wheel Ø 160 mm.

Dimensions

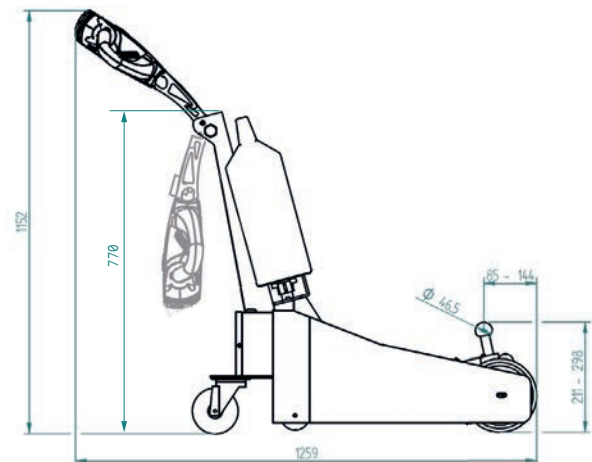
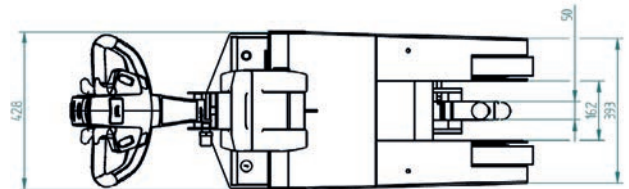

Standard parts



Motor 300W / 100rpm
(6911345X) without brake
Item number M1032



LED battery indicator
Item number M0123



Charger (external)
AGM battery 24V / 5A
Item number OPT0009



Battery AGM-VRLA green
24V / 22Ah
Item number OPT0110



Drive wheel
Ø 200 x 50 mm
Item number M0340



Castor wheel
Black Ø 125 mm
Item number M0110

Standard parts



Adjustable tiller head
Item no M1002-0100



Belly button RED
Item number M0121-BBUT



2 programmable speeds

Options



Horn 90dB for
cast iron tiller head supp.
M1002
Item number OPT0045



Horn 90dB for
steel tiller head supp.
M1002-0100
Item number OPT0057

Options



Horn 103dB
Item number OPT0059



Emergency stop complete
Item number OPT0063



Strobe light for
cast iron tiller head supp.
M1002
Item number OPT0076



Strobe light for
steel tiller head supp.
M1002-0100
Item number OPT0065

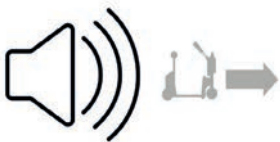

Audio signal
(while driving)
Item number OPT0253

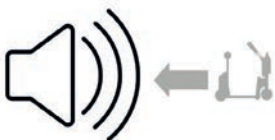

Audio signal
(driving backward)
Item number OPT0254

Options



Electromagnetic
parking brake
Item number OPT0004



Hour tracker
Item number OPT0056



Antistatic strip
Item number OPT0058



Code lock
Item number OPT0068

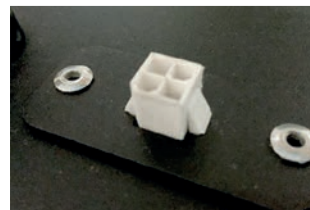

Diagnostic connector
Item number OPT0270



Ignition key (unequal)
Item number OPT0145

Options



Ignition key 701 (equal)
Item number OPT0146



On/off rotary switch
Item number OPT0016



Parking floorlabel Ø 60 cm
Item number OPT0245



Customized programming
Please indicate specific settings
Item number OPT0170



Programmer for Italsea
Item number D0003

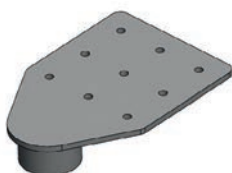

Screw tube
Item number OPT0301

Options

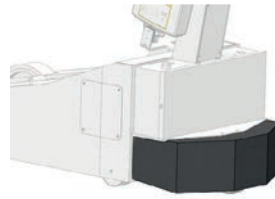

Safety fender
Item number OPT0212



Urgent order purchase
Item number SPOED

Batteries and Chargers



Battery AGM-VRLA green
24V / 22Ah
Item number OPT0110



Charger (external)
AGM battery 24V / 5A
Item number OPT0009



Battery Lithium green
(LiFePO4) 25,6V / 36Ah
Item number OPT0106

Batteries and Chargers



Charger (external)
Lithium battery 25,6V / 10A
Item number OPT0013



UPGRADE:
Battery Lithium (LiFePO4)
+ charger
Item number OPT0107



Wall mounted AGM
charger, incl. AGM
charger 24V / 5A
Item number OPT0015



Wall mounted Lithium
charger, incl. Lithium
charger 25,6V / 10A
Item number OPT0023



Wall mounted Lithium
charger (5x), incl. Lithium
charger 25,6V / 10A
Item number OPT0029



Wall mounted AGM
charger (5x), incl. AGM
charger 24V / 5A
Item number OPT0039

Batteries and Chargers



UPGRADE:
Wall mounting for charger
(for AGM or Lithium)
Item number OPT0261

Most common spareparts



Battery AGM-VRLA green
24V / 22Ah
Item number OPT0110



Charger (external)
AGM battery 24V / 5A
Item number OPT0009



Battery Lithium green
(LiFePO4) 25,6V / 36Ah
Item number OPT0106



Charger (external)
Lithium battery 25,6V / 10A
Item number OPT0013

Most common spareparts



Battery guide
(stainless steel)
Item number M0482



Battery connector SB50
Item number M0105



Belly button RED
Item number M0121-BBUT



Switch buttons (2x) green
Item number M0121-KNOP-GROEN



Switch tiller head
excl. buttons
Item number M0121-FLIPPER



Feather/shaft Throttle
Item number M0121-4

Most common spareparts



Switch FAST/SLOW
tiller head green
Item number M0121-SPEED-GROEN



Switch UP/DOWN
tiller head green
Item number M0121-UPDOWN-GROEN



Plain sleeve bearing
Ø8 / 12 x 6, 16 x 2 mm
Item number M4038



Locking pin
M16 x 1,5 mm
Item number M0001



Coverplate tiller head
Item number M0898



Italsea drive controller
in 24V / 36 bat,
in 10A / I_{max} 45A
Item number M1122

Most common spareparts



Carbon brushes (set of 4)
for Motor 300W
Item number M0186



LED battery indicator
Item number M0123



Cable harness complete
Item number M1127-M050



Fuse 5A
Item number M0506

Most common spareparts



Fuse Maxi 40A
Item number M0254



Drive wheel
Ø 200 x 50 mm
Item number M0340



Wheel
Black Ø 80 mm
Item number M0319



Castor wheel
Black Ø 125 mm
Item number M0110

applications



moveXX
driven by brain power

Generatorstraat 17-19
3903 LH Veenendaal
The Netherlands

T +31 (0)318 519900
E info@movexx.com
W www.movexx.com

