

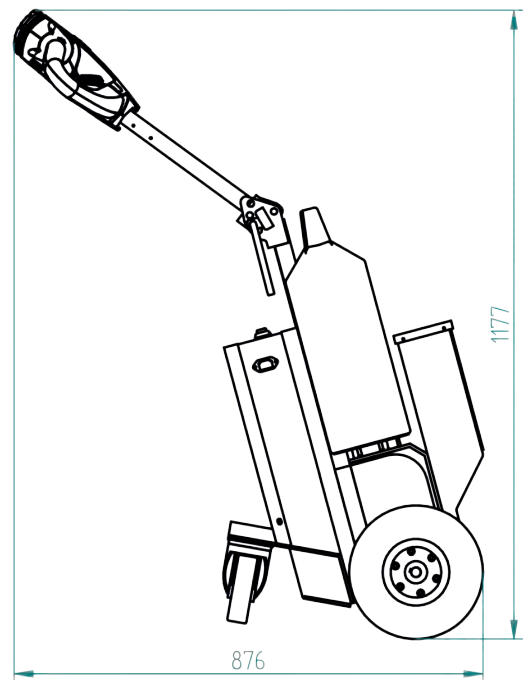

Specifications T1500-RVS

Frame	Stainless steel, glass pearl blasted
Drive	24V DC, 600W, 100 rpm
Weight	105 kg
Weight trailer	1500 kg
Battery	Exchangable batterypack
Speed	Max. 4,7 km/h
Drive wheels	Full rubber ø250x80 mm
Width	483mm
Length	876mm
Adze height	750-1177mm (variable)
Folded	770mm
Noise level	68,5 dB
To use from	-40 °C / 70 °C
Protection class	Machine IP44

Dimensions T1500-RVS

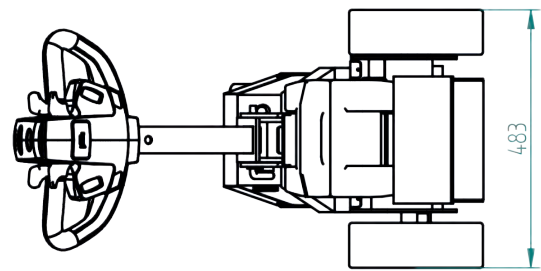

Pulling power T1500-RVS (in kg)

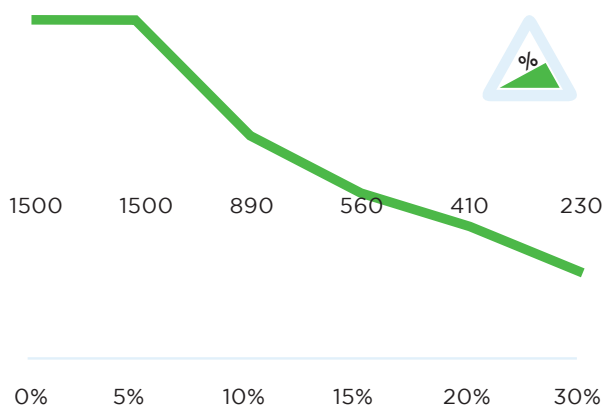

**Measured with a trolley with 2 swivelwheels and 2 fixed castors. Wheel diameter: 160mm*

Standard T1500-RVS



Standard parts T1500-RVS

Charger 24V 5A incl. charging cable



Item number:
OPT0009

Batterie AGM 22Ah



Item number:
OPT0110

SURCHARGE driving wheel non-marking YELL



Item number:
OPT0163

Adjustable tillerhead



Item number:
Standardpart 1

Safety switch



Item number:
Standardpart 2

2 programmable speeds



Item number:
Standardpart 3

Standard parts T1500-RVS

Engine 600W 100RPM
BRAKE 6911413X



Item number:
M2098

LED battery indicator
LBF318-24V



Item number:
M0123

Options T1500-RVS



Extra plug to recharge the battery

for on-machine batterie charging

Article number:
OPT0001



Battery Lithium-LiFePO4,
36Ah GREEN

Article number:
OPT0106



Battery upgrade to Lithium-LiFePO4, 36Ah

iso AGM Battery (!) Including upgrade to lithium charger 10A

Article number:
OPT0107



Batterie AGM 22Ah

Article number:
OPT0110



Emergency stop complete

Article number:
OPT0063



Acoustic signal driving backwards

Article number:
OPT0254



Flashlight tube tiller head support (st)

Article number:
OPT0415



Radio remote control

6 channel

Article number:
OPT0026-4



Document holder with clip

Article number:
OPT0053



hour counter complete

Article number:
OPT0056



Antistatic strip

Article number:
OPT0058



Code lock

Article number:
OPT0068

Options T1500-RVS



Preparation electric hook

Article number:
OPT0143



Ignition key unequal key

Article number:
OPT0145



Ignition key equal key 701

Article number:
OPT0146



Customized programming

please indicate specific settings

Article number:
OPT0170

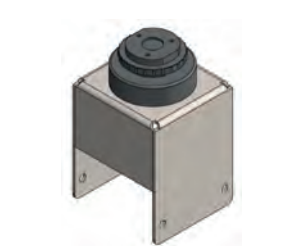

Horn for sleeve drawbar support (stainle)

Article number:
OPT0414



Programmer for Italsea

Article number:
D0003



Wall mounted Charger, for AGM battery

Complete charger-unit Including AGM battery charger (5 Ah)

Article number:
OPT0015



Stainless Charger For 1 AGM battery

Article number:
OPT0015-RVS



Charging Station for 1 Lithium battery

Wallmounting chargerstation with lithium battery charger 29,2 V, 10 A

Article number:
OPT0023



Charging station for 5 Lithium batteries

Article number:
OPT0029



Charging station for 5 batteries

Upright standing charging station with five separate AGM battery chargers 24 V, 5 A

Article number:
OPT0039



Stainless charger for 5 batteries

Article number:
OPT0039-RVS

Options T1500-RVS



Upgrade to charging station

Article number:
OPT0261

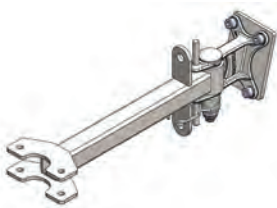

Base part hook 15° Stainless steel

Article number:
H7011



Hook locking system

Article number:
OPT0012



Lifting module for Hooks stainless steel

Article number:
OPT0050-RVS



Electrical locking module for hook

Article number:
OPT0129



Movexx Parking label

Article number:
OPT0245



HA245.55.45.0.0 (RVS)

Article number:
H0004 CLEAN RM



HD245.10.35.0.50

Fronthook for Hatchery trolleys (EMKA)

Article number:
H0090

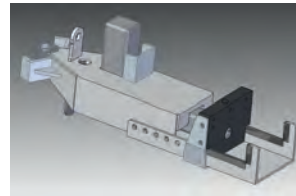

Clamping Hook Stainless steel

Article number:
H0096

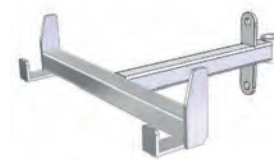

Clean Room Hook for hatching trolleys

HA360.34.26.0.0 Stainless Steel

Article number:
H0111



Coupling nettingscontainer,

Nettings 6mm

Article number:
K0007



Coupling rollcontainer

Nettings 10mm.

Article number:
K0008

Options T1500-RVS



Coupling Rollcontainer

Width 42 mm.

Article number:
K0010



Coupling Rollcontainer

Suitable for rack Ø6 mm. (Deli XL)

Article number:
K0012

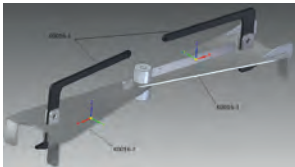

Coupling for Norm trolleys

Article number:
K0016



Angle limitation hook 15 degrees

Article number:
OPT0218

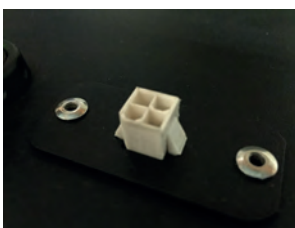

Diagnostic connector

Article number:
OPT0270



Charging station replacement battery wit

Article number:
OPT0339



Movexx International B.V.

Generatorstraat 17

3903 LH Veenendaal

Tel +31 (0)318 51.99.00

Fax +31 (0)318 50.80.20

E-mail info@movexx.nl